

MechaTronix in LED

LPF6768-ZHP Pin Fin LED Cooler ø67mm



Features & Benefits

- For spot and downlight designs from 1,100 to 3,300 lumen
- Thermal resistance Rth 2.1°C/W
- Modular design with mounting holes foreseen for a wide range of LED modules and COB's:
 - Zhaga Book 3 Spot Light Modules Edison Edilex SLM, Osram PrevaLED Core AC / AC PRO / Z3 / Z4, Philips Fortimo SLM, Seoul Semiconductor Acrich3, Sharp INTERMO, Tridonic Talexx Stark SLE G3 / G4, Vossloh Schwabe Luga Shop, ...
 - Bridgelux BXRA ESR, Vero & Décor Vero 13 / 18, V-series
 - Citizen Citiled CLL022-CLU024-CLU026, CLL032-CLU034-CLU036, CLU700, CLU710, CLU720
 - Cree XLamp CXA13, CXB13, CXA15, CXB15, CXA18, CXB18
 - Edison EdiPower II / EdiPower III HM09, HM13, HM16, HM24, HM30
 - Lustrous LUSTRON 6 series LL613F / LL620F
 - LG Innotek LEMWM18 10W, 13W, 17W, 24W
 - Osram Soleriq P6, P9, S13, S19, E30
 - Lumileds Luxeon COB's 1203, 1204, 1205, 1208, Luxeon K arrays K12, K16
 - Prolight Opto PACE, PACF, PABA, PACB, PACC
 - Seoul Semiconductor ZC6, ZC12, ZC18, ZC25, ZC40
 - Sharp Mega Zenigata, Tiger Zenigata, Mini Zenigata
 - Tridonic Talexx Stark SLE GEN3 LES-17, Talexx SLE GEN4 10/15/19/23mm, GEN5 06/11/15/19/23mm
- Diameter 67mm - Height 68mm
Other heights on request
- Better performance under tilted position
- Forged from highly conductive aluminum



Order Information

Example : LPF6768-ZHP-B

LPF6768-ZHP- **1**

- 1** Anodising Color
 - B - Black
 - C - Clear
 - Z - Custom (specify)

The LPF6768-ZHP pin fin LED cooler is designed in this way that you can mount LED modules from various manufacturers on the same LED cooler
This LED cooler is thermally validated for all our eco partners mentioned on the left side

MechaTronix in LED

LPF6768-ZHP Pin Fin LED Cooler ø67mm



Product Details

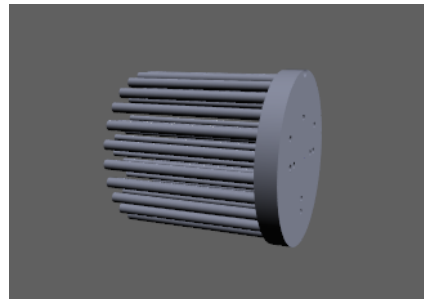

Model n°

LPF6768-ZHP

Dimension (mm) ^{*1}	ø67 x h68
Volume (mm ³)	63378
Cooling Surface (mm ²)	56108
Weight (gr)	171
Thermal Resistance (°C/W) ^{*2}	2.1
Power Pd (W) ^{*3}	24
Heat Sink Material	AL1070

^{*1} 3D files are available in ParaSolid, STP and IGS on request

^{*2} The thermal resistance Rth is determined with a calibrated heat source of 30mm x 30mm central placed on the heat sink, Tamb 40° and an open environment. Reference data @ heat sink to ambient temperature rise Ths-amb 50°C
The thermal resistance of a LED cooler is not a fix value and will vary with the applied dissipated power Pd

^{*3} Dissipated power Pd. Reference data @ heat sink to ambient temperature rise Ths-amb 50°C
The maximal dissipated power needs to be verified in function of required case temperature Tc or junction temperature Tj and related to the estimated ambient temperature where the light fixture will be placed
Please be aware the dissipated power Pd is not the same as the electrical power Pe of a LED module

To calculate the dissipated power please use the following formula: $Pd = Pe \times (1 - \eta_L)$

Pd - Dissipated power

Pe - Electrical power

η_L = Light efficiency of the LED module

Notes:

- MechaTronix reserves the right to change products or specifications without prior notice.
- Mentioned models are an extraction of full product range.
- For specific mechanical adaptations please contact MechaTronix.

MechaTronix in LED

LPF6768-ZHP Pin Fin LED Cooler ø67mm



Mounting Options

The LPF6768-ZHP Pin Fin LED coolers are standard foreseen from a variety of mounting holes which allow direct mounting of LED engines, COB's and secondary optics on the LED heat sink.

In this way mechanical afterwork and related costs can be avoided, and lighting designers can standardize their designs on a limited number of LED coolers.

Below you find an overview of LED modules and COB's which standard fit on the LPF6768-ZHP Pin Fin LED cooler.

MechaTronix performs thermal validation tests on each of the LED modules mounted on the LED cooler and publishes this data in the LED brand thermal validation reports.

For more details about the required mounting holes and thermal results for your specific LED brand and model, please refer to the brand LED cooler datasheets under "Brand Products" and the brand LED cooler overview under the "Download" menu.

Zhaga



The Zhaga Consortium is developing specifications that enable the interchangeability of LED light sources made by multiple different manufactures. The Zhaga specifications, known as Books, describe the interfaces between LED luminaires and LED light engines. Zhaga's members include hundreds of companies from throughout the global lighting industry. The cooperation is governed by a consortium agreement that defines rules regarding confidentiality, intellectual property and decision making.

Mounting indicator marks overview

MechaTronix recommends the use of a high thermal conductive interface between the LED module and the LED cooler. Either thermal grease, a thermal pad or a phase change thermal pad thickness 0.1-0.15mm is recommended. Thermal pads or phase change thermal pads can be pre-applied from MechaTronix.

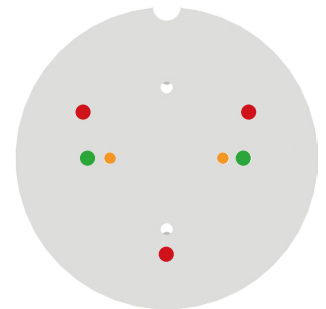

Zhaga Book 3 Spot Light Modules

Zhaga Interface Specification Book 3 defines the interfaces of LED light engines (LLEs) comprising a circular, non-socketable LED module with a separate LED driver (electronic control gear).

The circular LED modules in Book 3 have a typical diameter of 50 mm and a maximum height of 7.2 mm. Zhaga Book 3 LED modules are mounted by 2 M3 screws evenly located on diameter of 35mm on the LED cooler.

There are four LLE categories in Book 3, which are defined by the maximum diameter of the circular light-emitting surface (LES): 9 mm, 13.5 mm, 19 mm, 23 mm.

Book 3 LLEs are suitable for spot-lighting and other applications that benefit from a small, circular source.



Zhaga book 3 compliant LED Spot Light modules *1

- Edison Edilex SLM
- Osram PrevaLED CORE
- Philips Fortimo SLM
- Seoul Semiconductor ACrich3
- Sharp INTERMO
- Tridonic Tallex Stark SLE
- Vexica Lumaera
- Vossloh Schwabe Luga Shop

*1 This is a non-binding overview of available Zhaga book 3 LED modules at press

Zhaga Book 3 mounting through the use of LED holders and connectors

With the use of Zhaga Book 3 mechanical compatible LED holders, a wide variety of LED COB's can be mounted in the same way on these LED coolers.

Zhaga Book 3 compatible LED holders can be found from BJB, TE Connectivity (Tyco), Molex and Ideal Industries.

MechaTronix in LED

LPF6768-ZHP Pin Fin LED Cooler ϕ 67mm



Mounting Options



Zhaga Book 3 Spot Light Modules

LED COB's for which Zhaga book 3 LED holders are available

- Bridgelux V15, V18, ES rectangular
- Citizen CitiLED CLL032, CLU034, CLU036, CLL042, CLU044, CLU046, CLU710 - CLU720 - CLU730
- Cree XLamp CXA / CXB 18xx, 25xx, 30xx
- Edison Opto HM16, HM24, HM30, HM40
- Lextar Nimbus 2000, 3000, 5000
- LG Innotek LEMWM18 (10W, 13W, 17W, 24W), LEMWM28 (40W)
- Lustrous Lustron LL613F, LL620F, LL630F, LL630D, LL660D
- Nichia J216, J360, L110, L121, L204
- Osram Soleriq P13, S13, S19, E30
- Lumileds Luxeon 1203, 1204, 1205, 1208, 1211 and 1216 Luxeon K12 and K16
- Prolight Opto PABA, PACC, PACD, PACF, PACG
- Samsung LC026, LC040
- Seoul Semiconductor ZC12, ZC18, ZC25, ZC40, ZC60
- Sharp Mega Zenigata and Tiger Zenigata
- Tridonic TALEXX Stark SLE Gen3 Mini LES 17 TALEXXmodule SLE Gen4 / Gen5 15mm

Mounting

- Direct mounting with 2 M3 screws
- Green indicator marks

Reflector ring Mounting

- This optional ring can be mounted on top of the Edison Opto EdiLex spot light module and provides in this way an easy plug-and-play attachment of various reflectors.
- Mounting with 3 self tapping screws M3 x 10mm
- Red indicator marks

Zhaga Book 11 Spot Light Modules

Zhaga Interface Specification Book 11 defines the interfaces of LED light engines (LLEs) comprising a circular, non-socketable LED module with a separate LED driver (electronic control gear). The LED modules in Book 11 have an overall diameter of 35 mm and a height of 3.5 mm. Zhaga Book 11 LED modules are mounted by 2 M3 screws evenly located on diameter of 25mm on the LED cooler. There are three LLE categories in Book 11, which are defined by the maximum diameter of the circular light-emitting surface (LES): 6.3 mm, 9.0 mm, 13.5 mm. Book 11 LLEs are suitable for spot-lighting and other applications that benefit from a small, circular source.



LED COB's for which Zhaga book 11 LED holders are available

- Bridgelux V10 / V13
- Citizen CitiLED CLL022, CLU024, CLU026, CLU700
- Cree XLamp CXA / CXB 13xx, 15xx
- Edison Opto HM05, HM09, HM13
- Lextar Nimbus 1500
- Osram Soleriq P6, P9, P13, S13
- Prolight Opto PACB, PACE
- Seoul Semiconductor ZC6
- Sharp Mini Zenigata
- Tridonic TALEXX Stark SLE Gen3 Mini LES 10 TALEXXmodule SLE Gen4 10mm, Gen5 06mm - 11mm

Mounting

- Direct mounting with 2 M3 screws
- Orange indicator marks

MechaTronix in LED

LPF6768-ZHP Pin Fin LED Cooler ø67mm



Mounting Options

Bridgelux LED Arrays



Bridgelux is a leading provider of high power, cost effective and energy efficient light emitting diode (LED) solutions. Leveraging patented light source technology, Bridgelux LED Arrays replace traditional technologies (such as incandescent, halogen, fluorescent and high intensity discharge lighting) with integrated solid state light sources enabling high performance and energy-efficient products for the general lighting market.

Mounting indicator marks overview

MechaTronix recommends the use of a high thermal conductive interface between the LED module and the LED cooler. Either thermal grease, a thermal pad or a phase change thermal pad thickness 0.1-0.15mm is recommended. Thermal pads or phase change thermal pads can be pre-applied from MechaTronix.

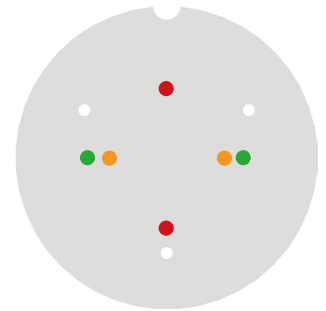

Bridgelux Vero 13 & Décor Vero 13 / Vero 18 & Décor Vero 18 LED Array

Model names

Model names

- Vero 13 BXRC-27x2000
- Vero 13 BXRC-30x2000
- Vero 13 BXRC-35E2000
- Vero 13 BXRC-40x2000
- Vero 13 BXRC-50x2000
- BXRC-xxA2001-C-23
- BXRC-xxH2000-C-xx
- Vero 18 BXRC-27x4000
- Vero 18 BXRC-30x4000
- Vero 18 BXRC-35E4000
- Vero 18 BXRC-40E4000
- Vero 18 BXRC-50C4000
- BXRC-xxA4001-F-23
- BXRC-xxH4000-F-xx
- BXRC-xxE4000-F-04
- BXRC-56G4000-F-04

Mounting

- Direct mounting with 2 screws M3 x 6mm
- Red indicator marks



Bridgelux V series V 10 / V 13 LED Array

Model names

- V10 BXRE-xxx1000-B-xx
- V13 BXRE-xxx2000-C-xx

Mounting

- With Zhaga Book 11 LED holder
- BJB spotlight connector 47.319.6214
- Mounting with 2 screws M3 x 6mm
- Orange indicator marks



MechaTronix in LED

LPF6768-ZHP Pin Fin LED Cooler ø67mm



Mounting Options

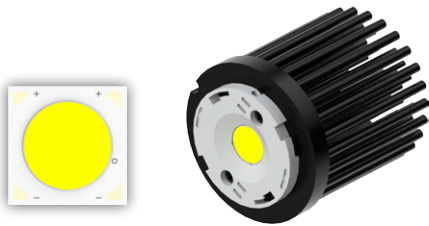

Bridgelux V series V 15 / V 18 LED Array

Model names

- V15 BXRE-xxx3001-D-xx
- V18 BXRE-xxx4000-F-xx

Mounting

- With Zhaga Book 3 LED holder
- BJB spotlight connector 47.319.2224
- Mounting with 2 screws M3 x 6mm
- Green indicator marks



Bridgelux ES Rectangle LED Array

Model names

- BXRA-xx0800
- BXRA-xx1200
- BXRA-xx2000
- BXRA-40E0950
- BXRA-40E1350
- BXRA-40E2200
- BXRA-xxC1100
- BXRA-xxC1600
- BXRA-xxC2600

Mounting

- With Zhaga Book 3 LED holder
- BJB spotlight connector 47.319.2040
- Mounting with 2 screws M3 x 6mm
- Green indicator marks

Citizen LED COB



Citizen Electronics Co., Ltd. is a precision electronics manufacturer with headquarters in Fujiyoshida City, Yamanash Japan. Prefecture and a subsidiary of Citizen Holdings Co., Ltd. Citizen Electronics is a leader in LED light sources for electronic devices and high power white LED lamps. The second generation CITED LED COB modules and the new upcoming generation CLU distinguish themselves through the combination of high lumen per watt performance combined with a perfect light quality control.

Mounting indicator marks overview

MechaTronix recommends the use of a high thermal conductive interface between the LED module and the LED cooler. Either thermal grease, a thermal pad or a phase change thermal pad thickness 0.1-0.15mm is recommended. Thermal pads or phase change thermal pads can be pre-applied from MechaTronix.

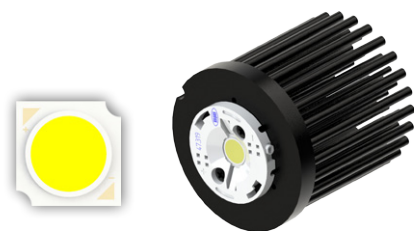
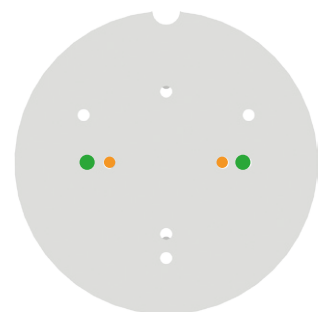

Citizen Cited CLL022 - CLU024 - CLU026

Model names

- CLL022-xxxx
- CLU024-xxxx
- CLU026-xxxxxx

Mounting

- With Zhaga Book 11 LED holder
- BJB Spotlight connector 47.319.6060
- Ideal Industries Chip-Lok™ holder 50-2002CT
- Mounting with 2 screws M3 x 6mm
- Orange indicator marks

MechaTronix in LED

LPF6768-ZHP Pin Fin LED Cooler ϕ 67mm



Mounting Options



Citizen Cited **CLL032 - CLU034 - CLU036**

Model names

- CLL032-xxxx
- CLU034-xxxx
- CLU036-xxxxxx

Mounting

- With Zhaga Book 3 LED holder
- BJB Spotlight connector 47.319.2021
- Ideal Industries Chip-Lok™ holder 50-2103CT
- TE Connectivity Lumawise type Z50 2213254-1
- TE Connectivity Lumawise type Z50 2213254-2
- Mounting with 2 screws M3 x 6mm
- Green indicator marks

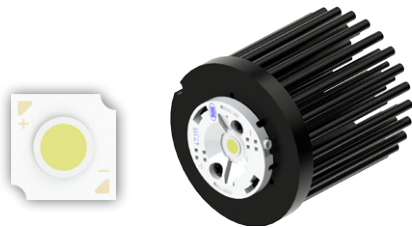

Citizen Cited High Intensity Type **CLU700**

Model names

- CLU700-1002B8

Mounting

- With Zhaga Book 11 LED holder
- BJB Spotlight connector 47.319.6060
- Ideal Industries Chip-Lok™ holder 50-2002CT
- Mounting with 2 screws M3 x 6mm
- Orange indicator marks



Citizen Cited High Intensity Type **CLU710 - CLU720**

Model names

- CLU710-1204B8
- CLU720-1206B8

Mounting

- With Zhaga Book 3 LED holder
- BJB Spotlight connector 47.319.2021
- Ideal Industries Chip-Lok™ holder 50-2103CT
- TE Connectivity Lumawise type Z50 2213254-1
- TE Connectivity Lumawise type Z50 2213254-2
- Mounting with 2 screws M3 x 6mm
- Green indicator marks

MechaTronix in LED

LPF6768-ZHP Pin Fin LED Cooler ø67mm



Mounting Options

Cree XLamp LED Array



Cree XLamp® LEDs deliver the industry's best lighting-class performance and are application-optimized to enable the lowest system cost.

Cree's new CXA LED Arrays deliver high lumen output and efficacy in a family of single, easy-to-use components. Optimized to simplify designs and lower system cost, Cree's CXA LED arrays are available in system level performance from 300 to over 16,000 lumens and can enable applications ranging from GU10s and commercial downlights to outdoor area lighting and high-bay lighting.

Mounting indicator marks overview

MechaTronix recommends the use of a high thermal conductive interface between the LED module and the LED cooler. Either thermal grease, a thermal pad or a phase change thermal pad thickness 0.1-0.15mm is recommended. Thermal pads or phase change thermal pads can be pre-applied from MechaTronix.

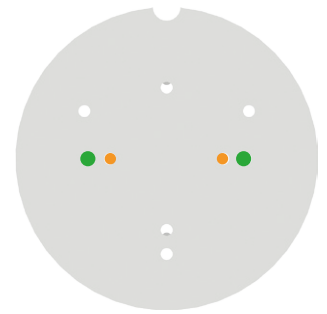

Cree XLamp CXA13 / CXB13 LED Array



Model names

- CXA1304-xxxx
- CXB1304-xxxx
- CXA1310-xxxx

Mounting

- With Zhaga Book 11 LED holder
- BJB Spotlight connector 47.319.6120
- Ideal Industries Chip-Lok™ holder 50-2000CR
- Mounting with 2 screws M3 x 6mm
- Orange indicator marks

Cree XLamp CXA15 / CXB15 LED Array



Model names

- CXA1507-xxxx
- CXB1507-xxxx
- CXA1512-xxxx
- CXB1512-xxxx
- CXA1520-xxxx

Mounting

- With Zhaga Book 11 LED holder
- BJB Spotlight connector 47.319.6101
- Ideal Industries Chip-Lok™ holder 50-2001CR
- Mounting with 2 screws M3 x 6mm
- Orange indicator marks

Cree XLamp CXA18 / CXB18 LED Array



Model names

- CXA1816-xxxx
- CXB1816-xxxx
- CXA1820-xxxx
- CXB1820-xxxx

Mounting

- With Zhaga Book 3 LED holder
- BJB Spotlight connector 47.319.2131
- Ideal Industries Chip-Lok™ holder 50-2101CR
- TE Connectivity Lumawise type Z50 2213401-1
- TE Connectivity Lumawise type Z50 2213401-2
- Mounting with 2 screws M3 x 6mm
- Green indicator marks

MechaTronix in LED

LPF6768-ZHP Pin Fin LED Cooler ø67mm



Mounting Options

Edison Opto LED Modules and COB's



Edison Opto with headquarters in Chung-Ho Dist, New Taipei City, Taiwan is a professional LED manufacture with specializes in designing and producing High-power LEDs, solid state lighting applications, LED sensors and SPDIFs. In response to rapid growth of capacity demand, Edison Opto has established factories in Dongguan and Yangzhou China and subsidiaries in USA and Germany. Edison Opto COB LED modules outstand in light quality and are available in the broadest lumen and CRI range available on the market.

Mounting indicator marks overview

MechaTronix recommends the use of a high thermal conductive interface between the LED module and the LED cooler. Either thermal grease, a thermal pad or a phase change thermal pad thickness 0.1-0.15mm is recommended. Thermal pads or phase change thermal pads can be pre-applied from MechaTronix.

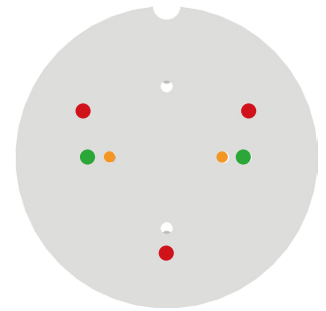

Edison Opto EdiPower II & EdiPower III HM series

Model names 9W - 13W

- 2PHM09xxxx
- 2PHM13xxxx

Mounting

- With Zhaga Book 11 LED holder
- Ideal Industries Chip-Lok™ holder 50-2002CT
- BJB Spotlight connector 47.319.6060
- Mounting with 2 screws M3 x 6mm
- Orange indicator marks



Model Names 16W - 30W

- 2PHM16xxxx
- 2PHM24xxxx
- 2PHM30xxxx

Mounting

- With Zhaga Book 3 LED holder
- BJB Spotlight connector 47.319.2021
- Ideal Industries Chip-Lok™ holder 50-2103CT
- TE Connectivity Lumawise type Z50 2213254-1
- TE Connectivity Lumawise type Z50 2213254-2
- Mounting with 2 screws M3 x 6mm
- Green indicator marks



Edison Opto EdiLex Spot Light Module (SLM)

Model names

- 5PHR09xxxx
- 5PHR11xxxx
- 5PHR22xxxx

Mounting

- Direct mounting with 2 screws M3 x 8mm
- Green indicator marks

Reflector ring Mounting

- This optional ring can be mounted on top of the Edison Opto EdiLex spot light module and provides in this way an easy plug-and-play attachment of various reflectors.
- Mounting with 3 screws M3 x 8mm
- Red indicator marks



MechaTronix in LED

LPF6768-ZHP Pin Fin LED Cooler ø67mm



Mounting Options

LG Innotek LED COB



LG Innotek is a global specialized material and component manufacturer who is making a better world through cutting edge core component technology that is leading the market and opening a smarter future through the development of new eco-friendly materials. With the world's highest production capacity as a single factory and a solid LED business base built over more than a decade, LG Innotek's Paju LED factory produces 2 billion chips a month. Their LEMWM COB LED modules deliver a perfect lumen per watt ratio in an uncompromised lighting quality.

Mounting indicator marks overview

MechaTronix recommends the use of a high thermal conductive interface between the LED module and the LED cooler. Either thermal grease, a thermal pad or a phase change thermal pad thickness 0.1-0.15mm is recommended. Thermal pads or phase change thermal pads can be pre-applied from MechaTronix.

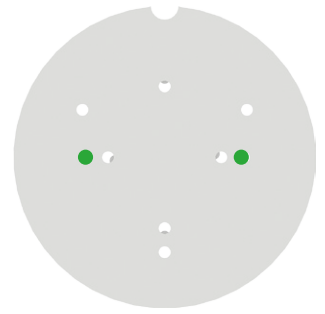

LG LEMWM18 10W / 13W / 17W / 24W COB

Model names

- LEMWM18580xxxx
- LEMWM18680xxxx
- LEMWM18780xxxx
- LEMWM18880xxxx

Mounting

- With Zhaga Book 3 LED holder
- BJB Spotlight connector 47.319.2080
- Ideal Industries Chip-Lok™ holder 50-2100LG
- Mounting with 2 screws M3 x 6mm
- Green indicator marks

Lumileds LED Array & COB



Lumileds LUXEON COB is a new breakthrough in efficacy for arrays. Due to its industry leading small Light Emitting Surfaces (LES), the COB array is very easy work with and will enable easier and less expensive designs. All LUXEON COBs are available in a single 3-step as well as a single 5-step MacAdam Ellipse, ensuring uniform optical performance in the application. Ideal applications include down lights and directional lamps.

Mounting indicator marks overview

MechaTronix recommends the use of a high thermal conductive interface between the LED module and the LED cooler. Either thermal grease, a thermal pad or a phase change thermal pad thickness 0.1-0.15mm is recommended. Thermal pads or phase change thermal pads can be pre-applied from MechaTronix.

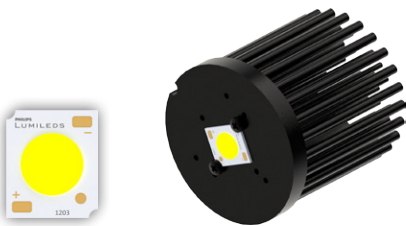
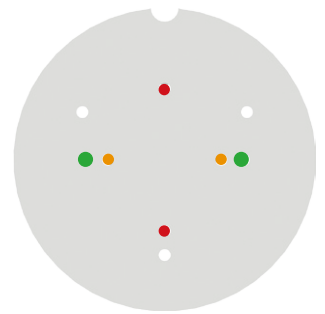

Luxeon COB 1203

Model names

- Luxeon COB LHC1-xxxx-1203

Mounting

- Direct mounting with 2 screws M3 x 6mm
- Orange indicator marks
- With Zhaga Book 3 LED holder
- Ideal Industries Chip-Lok™ holder 50-2100NC
- TE Connectivity Lumawise type Z50 2213382-1
- TE Connectivity Lumawise type Z50 2213382-2
- Mounting with 2 screws M3 x 6mm
- Green indicator marks

MechaTronix in LED

LPF6768-ZHP Pin Fin LED Cooler ø67mm



Mounting Options

Luxeon COB 1204 - 1205 - 1208

Model names

- Luxeon COB LHC1-xxxx-1204
- Luxeon COB LHC1-xxxx-1205
- Luxeon COB LHC1-xxxx-1208

Mounting

- Direct mounting with 2 screws M3 x 6mm
Red indicator marks
- With Zhaga Book 3 LED holder
BJB spotlight connector 47.319.2011
Ideal Industries Chip-Lok™ holder 50-2100SH
TE Connectivity Lumawise type Z50 2213130-1
TE Connectivity Lumawise type Z50 2213130-2
Mounting with 2 screws M3 x 6mm
Green indicator marks



Luxeon K arrays K12 - K16

Model names

- Luxeon K12 LXKx-Pxxx-xx12(A)
- Luxeon K16 LXKx-Pxxx-xx16(A)

Mounting

- With Zhaga Book 3 LED holder
BJB spotlight connector 47.319.2070
Mounting with 2 screws M3 x 6mm
Green indicator marks



Lustrous LED COB

LUSTROUS

Green Technology of Lighting

LUSTROUS unique Chip-on-Board (COB) packaging technology of High Power LED leads the core competence of LUSTROUS. COB packaging technology shows excellent thermal management and high efficiency performance. One of the benefits of COB is bright, uniform light output. The excellent low thermal resistance is achieved through state of the art COB technology on highly conductive substrates. This enables low junction temperatures at chip level for much higher efficiencies.

Mounting indicator marks overview

MechaTronix recommends the use of a high thermal conductive interface between the LED module and the LED cooler. Either thermal grease, a thermal pad or a phase change thermal pad thickness 0.1-0.15mm is recommended. Thermal pads or phase change thermal pads can be pre-applied from MechaTronix.

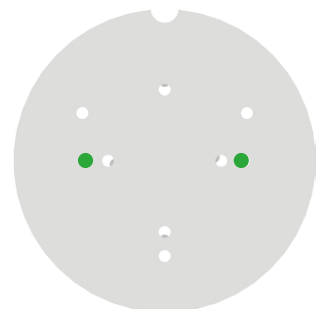

Lustrous Lustron LL613F - LL620F LED COB

Model names

- Lustron LL613F1206-xxx
- Lustron LL620F1208-xxx

Mounting

- With Zhaga Book 3 LED holder
BJB spotlight connector 47.319.2021
Ideal Industries Chip-Lok™ holder 50-2103CT
Mounting with 2 self tapping screws M3 x 6mm
Green indicator marks



MechaTronix in LED

LPF6768-ZHP Pin Fin LED Cooler ø67mm



Mounting Options

Osram PrevaLED LED Modules



With the PrevaLED Core and PrevaLED Core AC, Osram leads the path of versatile LED light modules interchangeable according Zhaga book 3 specifications. With an initial color binning below 3 steps Mc Adam, a wide range of lumen packages from 1.100lm all the way up to 5.000lm and a broad availability of color temperatures, the Osram PrevaLED Core found it's strive in high-end shop and down light applications with an uncompromised lighting quality.

Mounting indicator marks overview

MechaTronix recommends the use of a high thermal conductive interface between the LED module and the LED cooler. Either thermal grease, a thermal pad or a phase change thermal pad thickness 0.1-0.15mm is recommended. Thermal pads or phase change thermal pads can be pre-ap

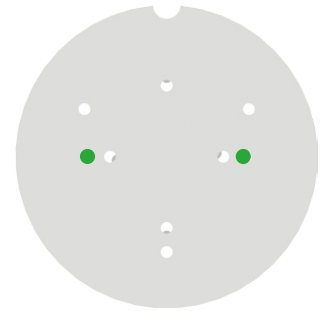

Osram PrevaLED Core Z3

Model names

- PL-CORE-1100-xxx-Z3
- PL-CORE-2000-xxx-Z3
- PL-CORE-3000-xxx-Z3

Mounting

- Direct mounting with 2 screws M3 x 8mm
- Green indicator marks



Osram PrevaLED Core Z4

Model names

- PL-CORE-Z4-2000-xxx
- PL-CORE-Z4-3000-xxx

Mounting

- Direct mounting with 2 screws M3 x 8mm
- Green indicator marks



Osram PrevaLED Core AC

Model names

- PL-CORE-AC-800-xx
- PL-CORE-AC-2000-xx

Mounting

- Direct mounting with 2 screws M3 x 8mm
- Green indicator marks



MechaTronix in LED

LPF6768-ZHP Pin Fin LED Cooler ø67mm



Mounting Options



Osram PrevaLED Core AC PRO

Model names

- PL-CORE-AC-PRO-2000-xxx
- PL-CORE-AC-PRO-3000-xxx

Mounting

- Direct mounting with 2 screws M3 x 8mm
- Green indicator marks

Osram Opto Semiconductors LED COB



Osram SOLERIQ® LEDs are designed to meet the requirements of professional indoor general lighting applications. Large flux output, small light emitting surfaces, variation, CRI greater than 80 and easy to use Chip-on-Board technology support easy and creative lighting design. These properties make SOLERIQ® LED COB modules a high efficient, high-quality and price-performance-optimized solution for all demanding and at the same time cost-conscious lighting manufactures and designers.

Mounting indicator marks overview

MechaTronix recommends the use of a high thermal conductive interface between the LED module and the LED cooler. Either thermal grease, a thermal pad or a phase change thermal pad thickness 0.1-0.15mm is recommended. Thermal pads or phase change thermal pads can be pre-applied from MechaTronix.

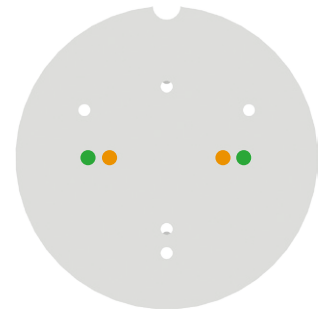

Osram Soleriq P6 LED COB

Model names

- GW MAEGB1.EM
- GW MAEGB1.CM

Mounting

- With Zhaga Book 11 LED holder
- BJB Spotlight connector 47.319.6190
- Mounting with 2 screws M3 x 6mm
- Orange indicator marks

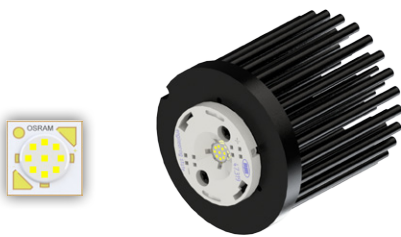

Osram Soleriq P9 LED COB

Model names

- GW MAFB1.EM
- GW MAFB1.CM

Mounting

- With Zhaga Book 11 LED holder
- BJB Spotlight connector 47.319.6200
- Mounting with 2 screws M3 x 6mm
- Orange indicator marks



MechaTronix in LED

LPF6768-ZHP Pin Fin LED Cooler ϕ 67mm



Mounting Options



Osram Soleriq S13 LED COB

Model names

- GW-KAGHB1.xxxx

Mounting

- With Zhaga Book 3 LED holder
Ideal Industries Chip-Lok™ holder 50-2101CR
TE Connectivity Lumawise type Z50 2213401-1
TE Connectivity Lumawise type Z50 2213401-2
Mounting with 2 screws M3 x 6mm
Green indicator marks
- With Zhaga Book 11 LED holder
BJB Spotlight connector 47.319.6111
Mounting with 2 screws M3 x 6mm
Orange indicator marks



Osram Soleriq S19 LED COB

Model names

- GW-KAHLB1.xxxx

Mounting

- With Zhaga Book 3 LED holder
BJB spotlight connector 47.319.2170
TE Connectivity Lumawise type Z50 2213407-1
TE Connectivity Lumawise type Z50 2213407-2
Mounting with 2 screws M3 x 6mm
Green indicator marks

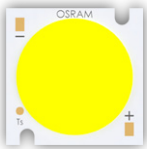

Osram Soleriq E30 LED COB

Model names

- GW KAJRB2.EM-STTQ->xxxx
- GW KAJRB2.EM-TPTR->xxxx

Mounting

- Direct mounting with 2 screws M3 x 6mm
Green indicator marks
- With Zhaga Book 3 LED holder
BJB Spotlight connector 47.319.2090
Mounting with 2 screws M3 x 6mm
Green indicator marks

MechaTronix in LED

LPF6768-ZHP Pin Fin LED Cooler ø67mm



Mounting Options

Philips LED Modules

PHILIPS

The third Philips Fortimo LED SLM generation is the ideal solution for spot lighting fixtures and highly efficient compact down light luminaires. It is specifically designed for the retail market showcasing retail merchandise in bright and vivid light. This generation is equipped with new Chip-On-Board (COB) LED technology. This technology enables the creation of the most efficient point source Philips LED system available.

Mounting indicator marks overview

MechaTronix recommends the use of a high thermal conductive interface between the LED module and the LED cooler. Either thermal grease, a thermal pad or a phase change thermal pad thickness 0.1-0.15mm is recommended. Thermal pads or phase change thermal pads can be pre-applied from MechaTronix.

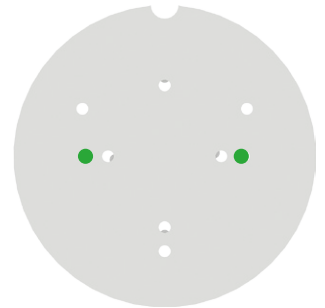

Philips Fortimo SLM Gen3 / Gen4 LED Modules

Model names

- Fortimo LED SLM 2000 G3
- Fortimo LED SLM 3000 G3
- Fortimo LED SLM 1100 G4
- Fortimo LED SLM 2000 G4
- Fortimo LED SLM 3000 G4

Mounting

- Direct mounting with 2 screws M3 x 6mm
- Green indicator marks

Prolight Opto LED COB



Founded in October 2004, Prolight Opto Technology Corporation is a professional manufacturer of LED packaging, dedicated to the research, development, and manufacturing of mid-to-high-power, high reliability LED packages. Prolight Opto continually invests over 6% of sales revenue in R&D and patents. With own package patents from the US and Taiwan they insure a wide range of LED emitters in the smallest foot prints and COB LED modules with perfect thermal management and high density lumen output.

Mounting indicator marks overview

MechaTronix recommends the use of a high thermal conductive interface between the LED module and the LED cooler. Either thermal grease, a thermal pad or a phase change thermal pad thickness 0.1-0.15mm is recommended. Thermal pads or phase change thermal pads can be pre-applied from MechaTronix.

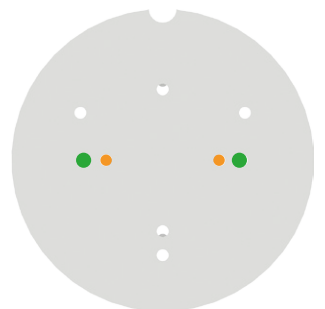

Prolight Opto BI series PABA COB

Model names

- PABA-10xxx-xxxx
- PABA-15xxx-xxxx
- PABA-22xxx-xxxx
- PABA-26xxx-xxxx
- PABA-35xxx-xxxx

Mounting

- With Zhaga Book 3 LED holder
- BJB spotlight connector 47.319.2040
- Mounting with 2 screws M3 x 6mm
- Green indicator marks

MechaTronix in LED

LPF6768-ZHP Pin Fin LED Cooler ϕ 67mm



Mounting Options

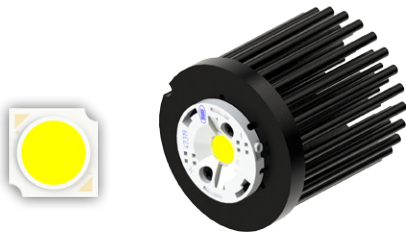

Prolight Opto CE series PACE COB

Model names

- PACE-7xxx-xxxx
- PACE-14xxx-xxxx
- PACE-21xxx-xxxx
- PACE-28xxx-xxxx

Mounting

- With Zhaga Book 11 LED holder
- BJB Spotlight connector 47.319.6060
- Mounting with 2 screws M3 x 6mm
- Orange indicator marks



Prolight Opto CII series PACF COB

Model names

- PACF-57xxx-xxxx

Mounting

- With Zhaga Book 3 LED holder
- BJB Spotlight connector 47.319.2021
- TE Connectivity Lumawise type Z50 2213254-1
- TE Connectivity Lumawise type Z50 2213254-2
- Mounting with 2 screws M3 x 6mm
- Green indicator marks

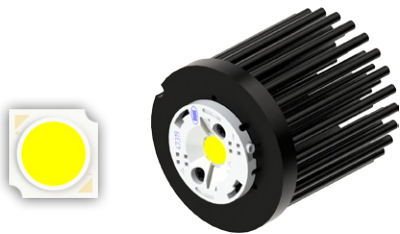

Prolight Opto CI series PACB COB

Model names

- PACB-5xxx-xxxx
- PACB-7xxx-xxxx
- PACB-9xxx-xxxx

Mounting

- With Zhaga Book 11 LED holder
- BJB Spotlight connector 47.319.6060
- Mounting with 2 screws M3 x 6mm
- Orange indicator marks



Prolight Opto CII series PACC COB

Model names

- PACC-18xxx-xxxx

Mounting

- With Zhaga Book 3 LED holder
- BJB Spotlight connector 47.319.2021
- TE Connectivity Lumawise type Z50 2213254-1
- TE Connectivity Lumawise type Z50 2213254-2
- Mounting with 2 screws M3 x 6mm
- Green indicator marks

MechaTronix in LED

LPF6768-ZHP Pin Fin LED Cooler ϕ 67mm



Mounting Options

Seoul Semiconductor LED COB



SEOUL SEMICONDUCTOR

The new Seoul Semiconductor ZC series Chip-On-Board (COB) LED Arrays offer high lumen density and efficacies of up to 140lm/W in a single, easy-to-use LED component family. Available in all major color temperatures from 2700K up to 6000K, these high flux packages deliver system level performance of 700 lumens to over 6,000 lumens. The new ZC series family is available in a single 3-step MacAdam Ellipse binning, ensuring excellent color consistency with minimum CRI options of 70, and 80 combining high quality of light with high efficacy.

Mounting indicator marks overview

MechaTronix recommends the use of a high thermal conductive interface between the LED module and the LED cooler. Either thermal grease, a thermal pad or a phase change thermal pad thickness 0.1-0.15mm is recommended. Thermal pads or phase change thermal pads can be pre-applied from MechaTronix.

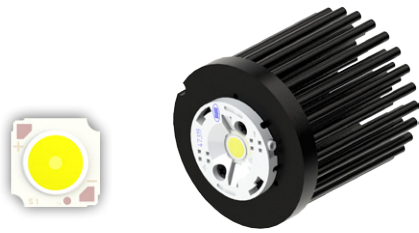
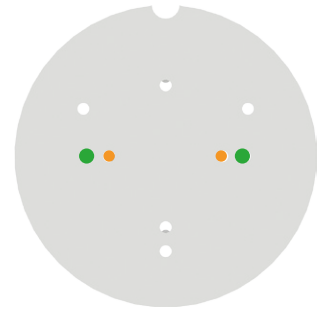

Seoul Semiconductor ZC 6 LED COB

Model names

- SDW01F1C
- SDW81F1C
- SDW91F1C

Mounting

- With Zhaga Book 11 LED holder
- BJB Spotlight connector 47.319.6060
- Ideal Industries Chip-Lok™ holder 50-2002CT
- Mounting with 2 screws M3 x 6mm
- Orange indicator marks



Seoul Semiconductor ZC 12 / ZC 18 LED COB

Model names

- SDW02F1C
- SDW82F1C
- SDW92F1C
- SDW03F1C
- SDW83F1C
- SDW93F1C

Mounting

- With Zhaga Book 3 LED holder
- BJB Spotlight connector 47.319.2021
- Ideal Industries Chip-Lok™ holder 50-2103CT
- TE Connectivity Lumawise type Z50 2213254-1
- TE Connectivity Lumawise type Z50 2213254-2
- Mounting with 2 screws M3 x 6mm
- Green indicator marks

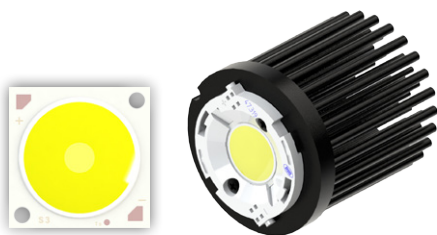

Seoul Semiconductor ZC 25 / ZC 40 LED COB

Model names

- SDW04F1C
- SDW84F1C
- SDW94F1C
- SDW05F1C
- SDW85F1C
- SDW95F1C

Mounting

- With Zhaga Book 3 LED holder
- BJB Spotlight connector 47.319.2030
- Ideal Industries Chip-Lok™ holder 50-2204CT
- Mounting with 2 screws M3 x 6mm
- Green indicator marks

MechaTronix in LED

LPF6768-ZHP Pin Fin LED Cooler ø67mm



Mounting Options

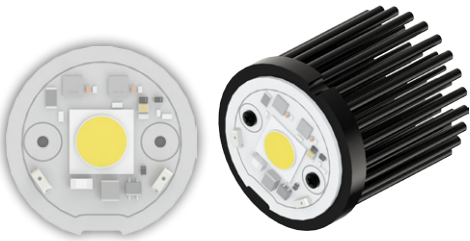

Seoul Semiconductor Acrich3 LED COB

Model names

- Acrich3 COB 30W

Mounting

- Direct mounting with 2 screws M3 x 6mm
- Green indicator marks

Sharp LED Modules & COB



Sharp Zenigata Chip on Board (COB) technology leverages 40 years of LED expertise to help your products outshine the competition with some of the highest brightness-per-watt in the industry. Sharp's new Mega Zenigata 50W – 80W modules take traditional, high-power lighting applications head on with power-saving LED alternatives. Sharp Devices Europe has launched an important new portfolio of LED modules dubbed INTERMO. The Standard INTERMO is a Zhaga Book 3 form-factor module, which ensures compatibility with a large eco-system of third-party products.

Mounting indicator marks overview

MechaTronix recommends the use of a high thermal conductive interface between the LED module and the LED cooler. Either thermal grease, a thermal pad or a phase change thermal pad thickness 0.1-0.15mm is recommended. Thermal pads or phase change thermal pads can be pre-applied from MechaTronix.

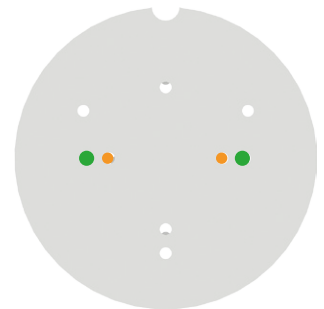

Sharp INTERMO Standard / Slim LED Modules

Model names

- GW7MMCxxGZC - 3000 lm
- GW7MGDxxGZC - 3000 lm
- GW7MMDxxGZC - 4000 lm
- GW7MGExxGZC - 4000 lm

Mounting

- Direct mounting with 2 screws M3 x 6mm
- Green indicator marks



MechaTronix in LED

LPF6768-ZHP Pin Fin LED Cooler ø67mm



Mounting Options



Sharp Mega Zenigata 15-25W/25-40W/35-50W LED COB

Model names

- GW5DxAxxM04
- GW6DxAxxNFC
- GW5DxCxxM04
- GW6DxCxxNFC
- GW6DxDxxNFC

Mounting

- With Zhaga Book 3 LED holder
- BJB spotlight connector 47.319.2011
- Ideal Industries Chip-Lok™ holder 50-2100SH
- Mounting with 2 screws M3 x 6mm
- Green indicator marks



Sharp Tiger Zenigata 25W LED COB

Model names

- GW6TGCBG40C

Mounting

- With Zhaga Book 3 LED holder
- BJB spotlight connector 47.319.2051
- Mounting with 2 screws M3 x 6mm
- Green indicator marks



Sharp Mini Zenigata 4-10W/10-15W/15-24W LED COB

Model names

- GW5BQCxxK03
- GW5BQFxxK03
- GW5BMFxxK04
- GW5BTJxxK03
- GW5BMCxxKG4
- GW6BxGxxHED
- GW5BMJxxK04
- GW6BxExxHED
- GW6BxWxxHED
- GW5BMRxxK05
- GW6BxRxxHED
- GW6BxSxxHED

Mounting

- With Zhaga Book 11 LED holder
- BJB spotlight connector 47.319.6180
- Ideal Industries Chip-Lok™ holder 50-2000P
- Mounting with 2 screws M3 x 6mm
- Orange indicator marks

MechaTronix in LED

LPF6768-ZHP Pin Fin LED Cooler ø67mm



Mounting Options

Tridonic LED Modules and COB



With the TALEXX LED products Tridonic gives you the confidence that your chosen lighting solution will give you precisely the results you want. Thanks to Tridonic's many years of experience in product development they have been able to raise the quality of light from their LEDs to new levels. The production series have an exceptionally constant light color so they guarantee a uniform and crystal clear color appearance. In addition to high efficiency and balanced distribution of light Tridonic offers you impressive robustness in the latest generation of their products and the resultant long life will save you maintenance and repair costs.

Mounting indicator marks overview

MechaTronix recommends the use of a high thermal conductive interface between the LED module and the LED cooler. Either thermal grease, a thermal pad or a phase change thermal pad thickness 0.1-0.15mm is recommended. Thermal pads or phase change thermal pads can be pre-applied from MechaTronix.

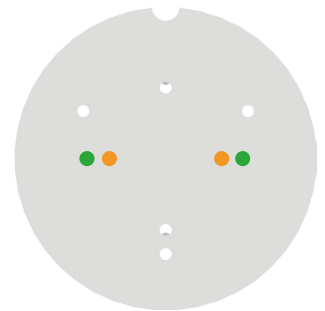

TALEXX Stark SLE GEN3 19 - 23 Select / Classic / Food / Art

Model names

- STARK-SLE-G3-19-xxx
- STARK-SLE-G3-23-xxx

Mounting

- Direct mounting with 2 screws M3 x 6mm
- Green indicator marks



TALEXX Stark SLE GEN3 Mini LES-17 Select / Classic / Art

Model names

- STARK-SLE-PURE-G3-17-xxx

Mounting

- With Zhaga Book 11 LED holder
- BJB Spotlight connector 47.319.2021
- Mounting with 2 screws M3 x 6mm
- Green indicator marks

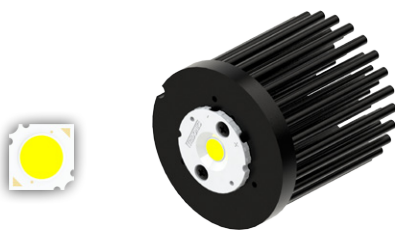

TALEXXmodule SLE GEN4 10mm Excite / Advanced / Essence

Model names

- SLE G4 10mm 1200lm xxx x EXC/ADV
- SLE G4 10mm 800lm xxx R SNC
- SLE G4 10mm 1200lm xxx R SNC

Mounting

- With Zhaga Book 11 LED holder
- Tridonic SLE G4 housing 28001038
- BJB Spotlight connector 47.319.6060
- Ideal Industries Chip-Lok™ holder 50-2002CT
- Mounting with 2 screws M3 x 6mm
- Orange indicator marks

MechaTronix in LED

LPF6768-ZHP Pin Fin LED Cooler ø67mm



Mounting Options

TALEXmodule SLE GEN4 15mm Excite / Advanced

Model names

- SLE G4 15mm 2000lm xxx x EXC/ADV

Mounting

- With Zhaga Book 3 LED holder
BJB Spotlight connector 47.319.2021
Ideal Industries Chip-Lok™ holder 50-2103CT
TE Connectivity Lumawise type Z50 2213254-1
TE Connectivity Lumawise type Z50 2213254-2
Mounting with 2 screws M3 x 6mm
Green indicator marks
- With Zhaga Book 11 LED holder
Tridonic SLE G4 housing 28001039
Mounting with 2 screws M3 x 6mm
Orange indicator marks



TALEXmodule SLE GEN4 15mm D50 - 19mm - 23mm Excite / Advanced

Model names

- SLE G4 15mm 2000lm xxx H EXC/ADV D50
- SLE G4 19mm 3000lm xxx x EXC/ADV
- SLE G4 23mm 5000lm xxx x EXC/ADV

Mounting

- Direct mounting with 2 screws M3 x 6mm
Green indicator marks



TALEXmodule SLE GEN5 06mm - 11mm Excite / Advanced

Model names

- SLE G5 06mm 1200lm xxx x EXC/ADV
- SLE G5 11mm 3000lm xxx x EXC/ADV

Mounting

- With Zhaga Book 11 LED holder
BJB Spotlight connector 47.319.6060
Ideal Industries Chip-Lok™ holder 50-2002CT
Mounting with 2 screws M3 x 6mm
Orange indicator marks



TALEXmodule SLE GEN5 15mm Excite / Advanced

Model names

- SLE G5 15mm 2000lm xxx x EXC/ADV
- SLE G5 15mm 3000lm xxx x EXC/ADV
- SLE G5 15mm 4000lm xxx x EXC/ADV

Mounting

- With Zhaga Book 3 LED holder
BJB Spotlight connector 47.319.2021
Ideal Industries Chip-Lok™ holder 50-2103CT
TE Connectivity Lumawise type Z50 2213254-1
TE Connectivity Lumawise type Z50 2213254-2
Mounting with 2 screws M3 x 6mm
Green indicator marks
- With Zhaga Book 11 LED holder
Tridonic SLE housing 28001039
Mounting with 2 screws M3 x 6mm
Orange indicator marks



MechaTronix in LED

LPF6768-ZHP Pin Fin LED Cooler ø67mm



Mounting Options



TALEXxmodule SLE GEN5 19mm - 23mm Excite / Advanced

Model names

- SLE G5 19mm 5000lm xxx x EXC/ADV
- SLE G5 23mm 6000lm xxx x EXC/ADV

Mounting

- Direct mounting with 2 screws M3 x 6mm
- Green indicator marks

Vossloh Schwabe LED Modules



Vossloh-Schwabe is an independent brand within the Panasonic Group responsible for the global development of the business area "Components for light technology". Panasonic employs 367,000 members of staff with an annual turnover of 76.75 billion Euros (8692.7 billion yen) and is represented throughout the world by more than 634 companies or representations in Asia, America and Europe. The Vossloh Schwabe Luga Shop LED modules are ideal solution for high-end luminaire designs where quality stands at the first place.

Mounting indicator marks overview

MechaTronix recommends the use of a high thermal conductive interface between the LED module and the LED cooler. Either thermal grease, a thermal pad or a phase change thermal pad thickness 0.1-0.15mm is recommended. Thermal pads or phase change thermal pads can be pre-applied from MechaTronix.

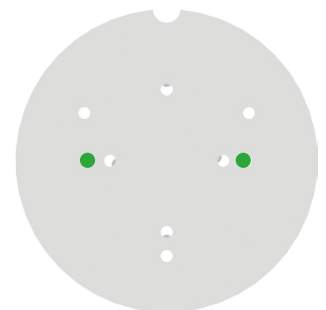

Luga Shop 2014 LED modules

Model names

- WU-M-484 / WU-M-461
- WU-M-485 / WU-M-462
- WU-M-486 / WU-M-464

Mounting

- Direct mounting with 2 screws M3 x 8mm
- Green indicator marks



Luga Shop 2014 Kit LED COB

Model names

- DMS088
- DMS128
- DMS158

Mounting

- With Luga Shop Kit holder
- Mounting with 2 screws M3 x 6mm
- Green indicator marks

MechaTronix in LED

LPF6768-ZHP Pin Fin LED Cooler $\phi 67$ mm



Drawings & Dimensions

Example: LPF6768-ZHP

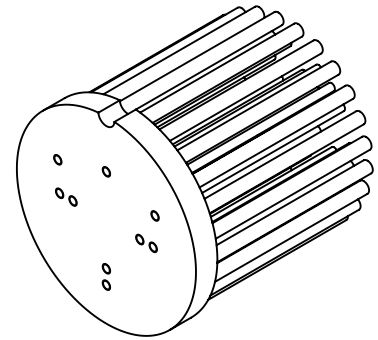
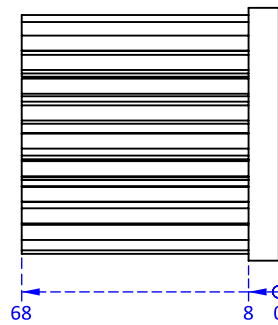
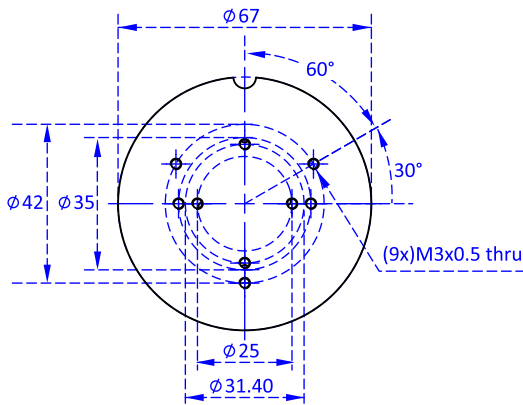

Thermal Data

$P_d = P_e \times (1 - \eta_L)$			LED Light efficiency, η_L (%)			Heat sink to ambient thermal resistance R_{hs-amb} ($^{\circ}C/W$)	Heat sink to ambient temperature rise T_{hs-amb} ($^{\circ}C$)
			17%	20%	25%		
Dissipated Power P_d (W)	3	Electrical Power P_e (W)	3.61	3.75	4.0	3.0	9
	5		6.02	6.25	6.67	2.8	14
	10		12.04	12.5	13.33	2.5	25
	15		18.07	18.75	20.0	2.3	35
	20		24.10	25.0	26.67	2.2	44
	25		30.12	31.25	33.33	2.1	53

Heat sink to ambient temperature rise T_{hs-amb} ($^{\circ}C$)

— LPF6768-ZHP

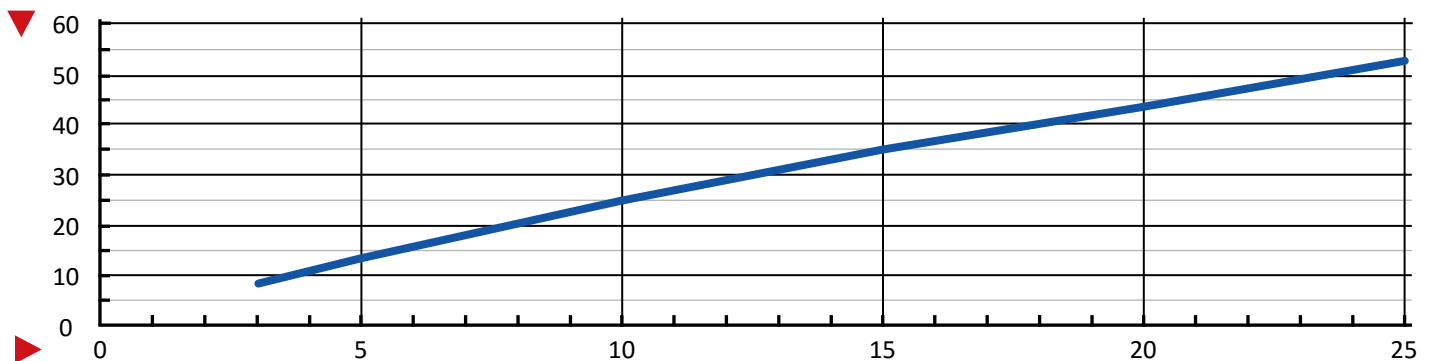

Dissipated Power P_d (W)