

**Piezosignalgeber RMP-28SW09-PT** Art.-Nr. 185575

**Specification:**

TYPE	UNIT	RMP-28SW09-PT
• Min. Sound Output at 30cm	dB	80
Rated Voltage	VDC	9
Operating Voltage	VDC	6~11
Resonant Frequency	Hz	2800±100
• Max. Current Consumption	mA	20
Tone		Pulse
Puls Rate at Rated Voltage	Pulse/Sec	2-7
Operating Temperature	°C	-20~+70
Storage Temperature	°C	-30~+70
Weight	g	10

- Value applying at rated voltage

**Dimensions:**

(Unit: mm)

Wire: UL 1007 #28

AWG 28

LEAD TYPE

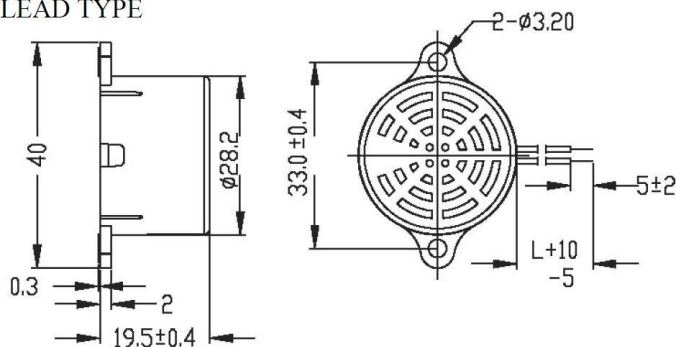

**Frequency response:**

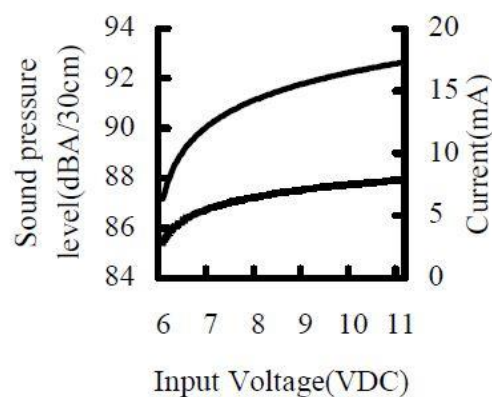

Version 1 / 10/2021