

Specifications:

1. General tolerance unless noted is $\pm 0.5\text{mm}$
2. Hole to Hole: 71.5mm
3. Holes dia.: $\varnothing 4.6\text{mm} \pm 0.2\text{mm}$
4. Outer ring dia.: $\varnothing 76.5\text{mm}$
5. Ring dia.: $\varnothing 1.8\text{mm} \pm 0.1\text{mm}$
6. Rib dia.: $\varnothing 1.8\text{mm} \pm 0.1\text{mm}$
7. Height: 5.5mm
8. Stagger welds: 5 rings

Material:

- Rings & Ribs Steel wire BL1-195(C1008)
- Surface Treating
Nickled-chrome electro plating surface, bright color
(Black color & other platings are available on request)
- Comply with the limits as set by RoHS / SVHC
- Weld Joins Contact Strength
Spot welding Points to withstand min. 88lbs(40Kgs.)
- Weight: 19.0Gm

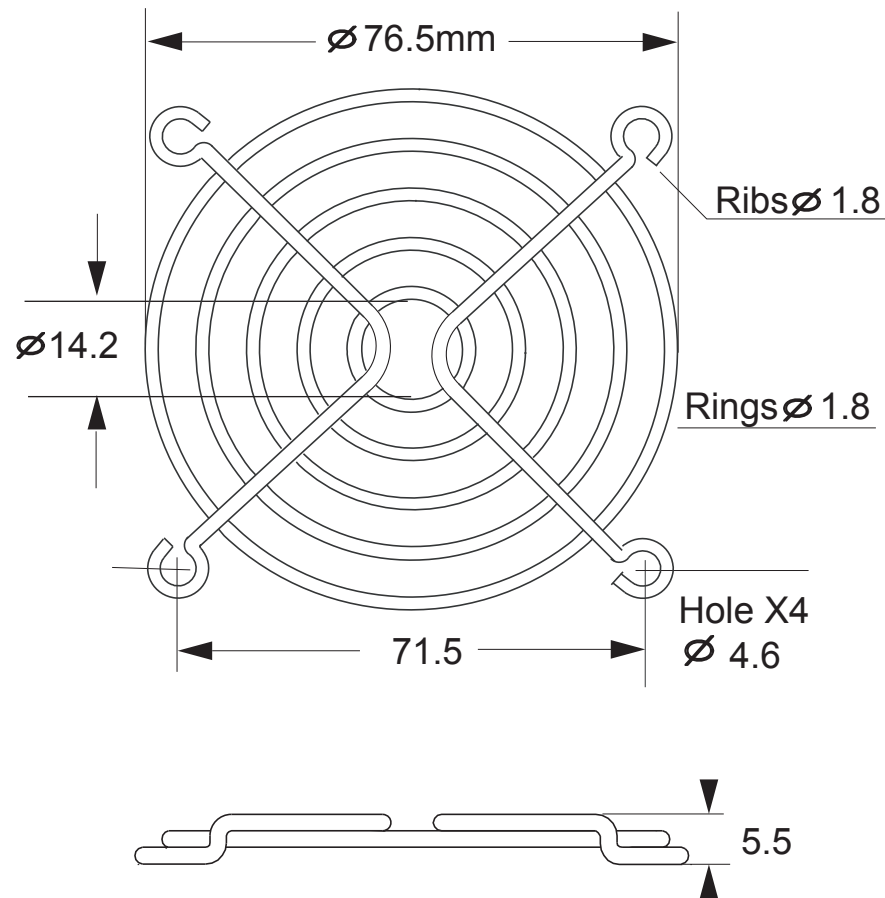

Model No:

RM-08EA

(Wire Form, Metal Fan Guard For 80mm (3.15") Fans)