

DLCV-100 SERIES

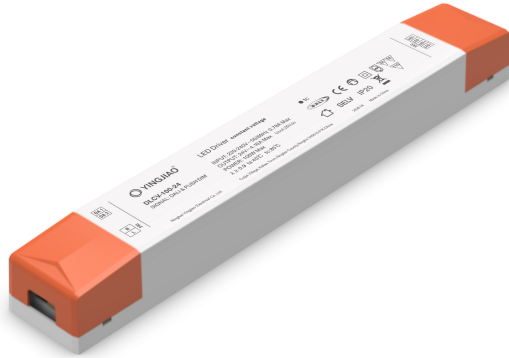

Input: 220-240V 50/60Hz
Output Voltage: 12V,24V
Rated Power: 100W max

Features

- Class II, SELV, Independent Power Supply
- DALI-2&PUSH(2 in 1) Dimmable
- Dimming range: 1-100%
- Fully-protected plastic housing with design of dismountable end cover.
- ERP :EU2019/2020
- Protection: Short circuit / Overload / Over voltage
- Warranty for 5 years



Application

- LED strips
- LED indoor lighting
- LED decorative lighting
- LED building lighting

■ Dimensions and Installation

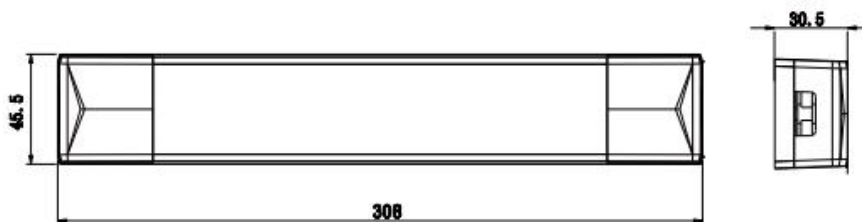

DLCV-100 SERIES

MODEL DETAIL SPEC.		DLCV-100-12	DLCV-100-24
INPUT	Input Voltage:	220-240VAC	
	Range of Input Voltage:	176-264VAC	
	Input Frequency:	50/60Hz	
	Input Current:	0.78AMAX@Full Load	
	Inrush Current:	Cold start 45Aat 230Vac	
	Leakage Current:	< 0.5mA/240VAC	
	THD (Full load):	< 10%	
	Efficiency:	89%	
	Displacement factor:	≥0.9	
	Power Factor:	≥0.95@Full Load 220-240VAC	
	Start-up time:	<0.5S	
	No Load Power:	≤0.5W	
	Standby Power:	≤0.5W	
	Network standby power	≤0.5W	
OUTPUT	DC Voltage:	12V	24V
	Rated Current(Max):	8.33A	4.16A
	Rated Power(Max):	100W	100W
	Voltage Tolerance:	±5%	
	Ripple and Noise:	400mVp-p	400mVp-p
	Output HF current ripple(>1KHz):	±1%	
	Output LF current ripple(<120Hz):	±1%	
	SVM:	≤0.4	
	Pst:	≤1	
Dimming	Dimming mode	DALI-2 IEC 62386-101,102,207 & Push Dimming (Corridor Function)	
	Dimming depth	1%	
	Dimming current range	1-100%	
	PWM Resolution	16 bit	
ENVIRONMENTAL	Operating Temperature Ta:	-20°C ~ +40°C	
	Storage Temp:	-20°C ~ +60°C	
	Maximum Case Temperature Tc:	+85°C	
	Humidity:	20 ~ 95% RH	
	Lifetime:	≥50,000h@Tc=75°C, full load	
PROTECTION	Over Load:	105-150%	
		Yes/Auto Restore	
	Over Voltage:	≥12.6VDC	≥25.2VDC
		Protection type: Auto Restore	
	Short Circuit:	Yes , Protection type: Auto Restore	
	Over Temperature Protection	Yes , Protection type: Auto Restore	
SAFETY & EMC	Safety Regulations:	IEC61347- 1, IEC61347-2- 13;EN61347- 1, EN61347-2- 13;EN61347-1;EN61347-2- 13, EN62384;EN55015	
	Withstand Voltage:	I/P-O/P:3750VAC	
	EMC Immunity:	EN61000-4-2,3,4,5,6,8,11, EN61547	
OTHER	Material and SizeSize:	PC,308*45.5*30.5mm±1mm	
	IP Grade:	IP20	

DLCV-100 SERIES

Note:

1. All parameters not specially mentioned are measured at 230VAC input, full load and 25°C of ambient temperature.
2. Ripple & Noise are measured at 20MHz of bandwidth by using a 300mm twisted pair-wire terminated with a 0.1uF & 47 uF parallel capacitor.
3. The DC input for this product is only used for emergency lighting and applies to functional and safety requirements, EMC is not considered.

Deduction Curve and Temperature

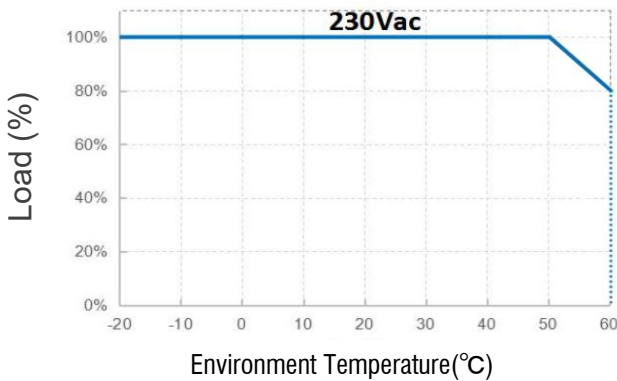

Minus Output and Input Voltage Curves

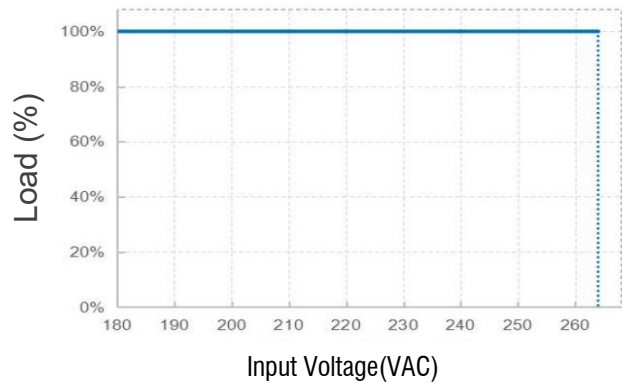

Power Factor (PF) Curves

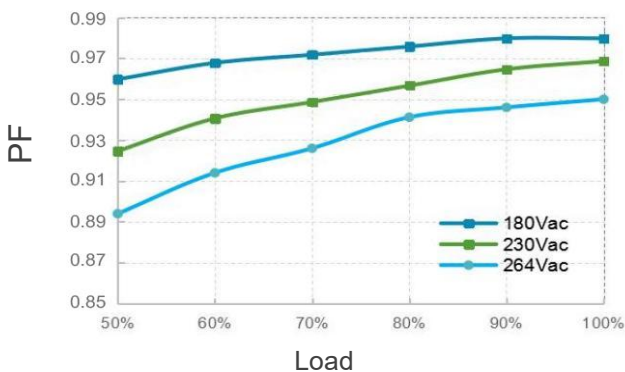

Efficiency Vs Load

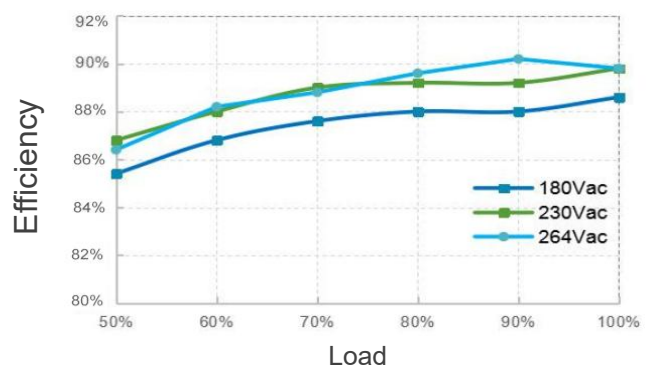

DLCV-100 SERIES

Wiring Diagram

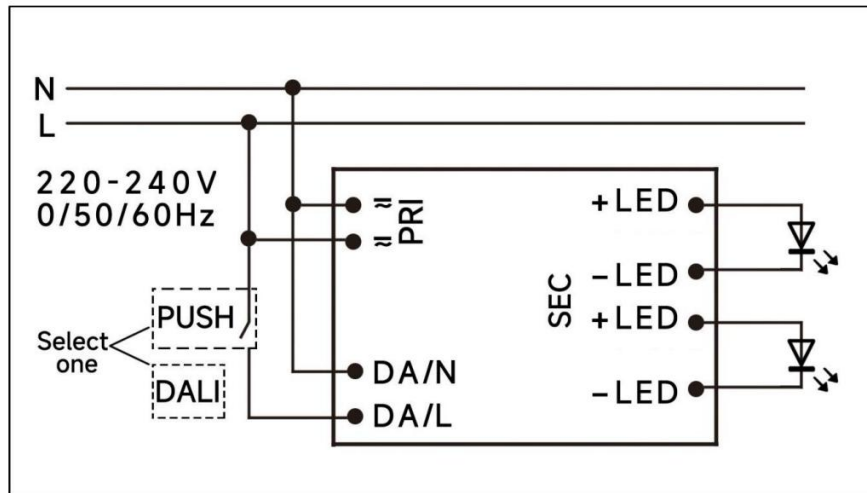

Wiring & Connections

Specification item		Value (Unit)
Input	Input wire cross-section	0.5...1.5 mm ²
	Input wire gauge.	16...20 AWG
	Input wire strip length	7...9mm
Output	Output wire cross-section	0.5...1.5 mm ²
	Output wire gauge.	16...20 AWG
	Output wire strip length	7...9mm

Manufacturer's address:

Cuijia, Xidian Town, Ninghai, Ningbo 315613, China

Tel: +86-574-87563856

<https://www.yingjiaodriver.com>